



USBoard-USS5-IP

Neobotix GmbH

Sep 11, 2023

1	USBoard-USS5-IP	1
1.1	Introduction	2
1.1.1	Intended Use	2
1.1.2	Improper Use	2
1.1.3	Qualified Personnel	2
1.2	Technical Data	2
1.2.1	USBoard-USS5-IP	2
1.2.2	Ultrasonic Sensor Bosch USS5	3
1.3	Dimensions	3
1.4	Connector Descriptions	4
1.4.1	Connectors	4
1.4.2	Primary Connector	5
1.4.3	Secondary Connector	6
1.5	Additional Parts	6
1.5.1	USBoard-USS5-IP Connectors	6
1.5.2	USBoard-USS5-IP Configuration Cable	6
1.5.3	Primary Cable Set	7
1.5.4	Secondary Cable Set	7
1.5.5	Sensors	7
1.6	Legal Notes	7
1.6.1	EU Declaration of Conformity	7
1.6.2	RoHS Information	7
2	USBoard-USS5	9
2.1	Introduction	10
2.1.1	Intended Use	10
2.1.2	Improper Use	10
2.1.3	Qualified Personnel	10
2.2	Operating Principle	10
2.2.1	Basic Principle	10
2.2.2	Cross Echo Mode	11
2.3	Technical Data	12
2.3.1	USBoard-USS5	12
2.3.2	Ultrasonic Sensor Bosch USS5	12
2.3.3	USS5 Field of View	13
2.4	Parameter Set	15

2.5	Command Set	17
2.5.1	Command IDs	17
2.5.2	CAN Communication	17
2.5.3	USB / Serial Interface	18
2.6	Commands	19
2.6.1	CMD_CONNECT	19
2.6.2	CMD_SET_CHANNEL_ACTIVE	19
2.6.3	CMD_GET_DATA_1TO8	20
2.6.4	CMD_GET_DATA_9TO16	20
2.6.5	CMD_WRITE_PARASET	20
2.6.6	CMD_WRITE_PARASET_TO_EEPROM	21
2.6.7	CMD_READ_PARASET	21
2.6.8	CMD_GET_ANALOGIN	22
2.6.9	CMD_GET_DATA	22
2.7	ROS Node	23
2.7.1	Installation	23
2.7.2	Launch	24
2.7.3	Parameters	24
2.7.4	Topics	25
2.7.5	Multiple USBoards	25
2.7.6	Help	26
2.8	ROS 2 Node	26
2.8.1	Installation	26
2.8.2	Launch	27
2.8.3	Parameters	27
2.8.4	Topics	28
2.8.5	Help	28
2.9	Graphical User Interface	28
2.9.1	Introduction	28
2.9.2	First Steps	29
2.9.3	Configuration	31
2.10	Dimensions	35
2.11	Connector Descriptions	36
2.11.1	X1	36
2.11.2	X2 - X5	36
2.11.3	X6	37
2.11.4	X7	37
2.11.5	USS5	37
2.12	Additional Parts	37
2.12.1	Connectors	37
2.12.2	USBoard-USS5 Configuration Cable	37
2.12.3	Sensor Cable Sets	38
2.12.4	Connector Sets	38
2.12.5	Ultrasonic Sensors	38
2.12.6	USS5 Mounting Frames	41
2.13	FAQ	41
2.13.1	General Questions	42
2.13.2	Connection Problems	42
2.14	Legal Notes	42
2.14.1	EU Declaration of Conformity	43
2.14.2	RoHS Information	43
3	Connectors	44
3.1	TE Connectivity - HE14	44

3.2	Würth Elektronik - MPC4	45
3.3	Würth Elektronik - MPC3	46
4	Qualified Personnel	48
5	Legal Notes	49
5.1	Version Information	49
5.2	Liability	49
5.3	Downloads and Further Information	49

CHAPTER 1

USBoard-USS5-IP

↓ Download as PDF¹



The USBoard-USS5-IP is a variant of the *USBoard-USS5* (page 9). It was designed for more demanding environmental conditions and mounting outside of a protective cabinet. Most of the basic functionality and properties of the USBoard-USS5-IP are identical to the USBoard-USS5. This documentation thus mainly describes the differences between the two boards.

¹ <https://neobotix-docs.de/hardware/en/USBoard-USS5-IP.pdf>

Tip: The Graphical User Interface is also the same as for the USBoard-USS5 and can be found at *Graphical User Interface* (page 28).

1.1 Introduction

1.1.1 Intended Use

The USBoard-USS5-IP was designed for use in mobile robots and similar machines like wheeled drones or AGVs. It is meant for obstacle detection and collision avoidance.

The USBoard-USS5-IP can also be used in stationary machines or equipment to provide distance measurement data.

The USBoard-USS5-IP was developed to provide exclusively non-safe data and information.

1.1.2 Improper Use

The USBoard-USS5-IP is explicitly **not a safety device** and must not be used as such. It must never be used to safeguard dangerous areas or as single system for collision avoidance.

It is not recommended to use the USBoard-USS5-IP in applications with very high requirements on measurement accuracy, on reliability of the measurements or on data output speed. This for example includes motion control applications like parking.

1.1.3 Qualified Personnel

The USBoard-USS5-IP must only be installed, connected and brought into service by *qualified personnel* (page 48).

1.2 Technical Data

1.2.1 USBoard-USS5-IP

- Supply voltage from +9 VDC up to +60 VDC, max. 4 W
- Digital communication via CAN and RS-232
- Solid state relay outputs for warning and alarm distance (max. 60 V, 0,5 A)
- Weight: 270 g
- Storage temperature range: -40 °C – 85 °C
- Operation temperature range: 0 °C – 50 °C
- Protection: IP67
- Customs tariff number: 9031 9000
- Order number: X102

1.2.2 Ultrasonic Sensor Bosch USS5

The technical data of the Bosch USS5 ultrasonic sensors can be found [here](#) (page 12).

1.3 Dimensions

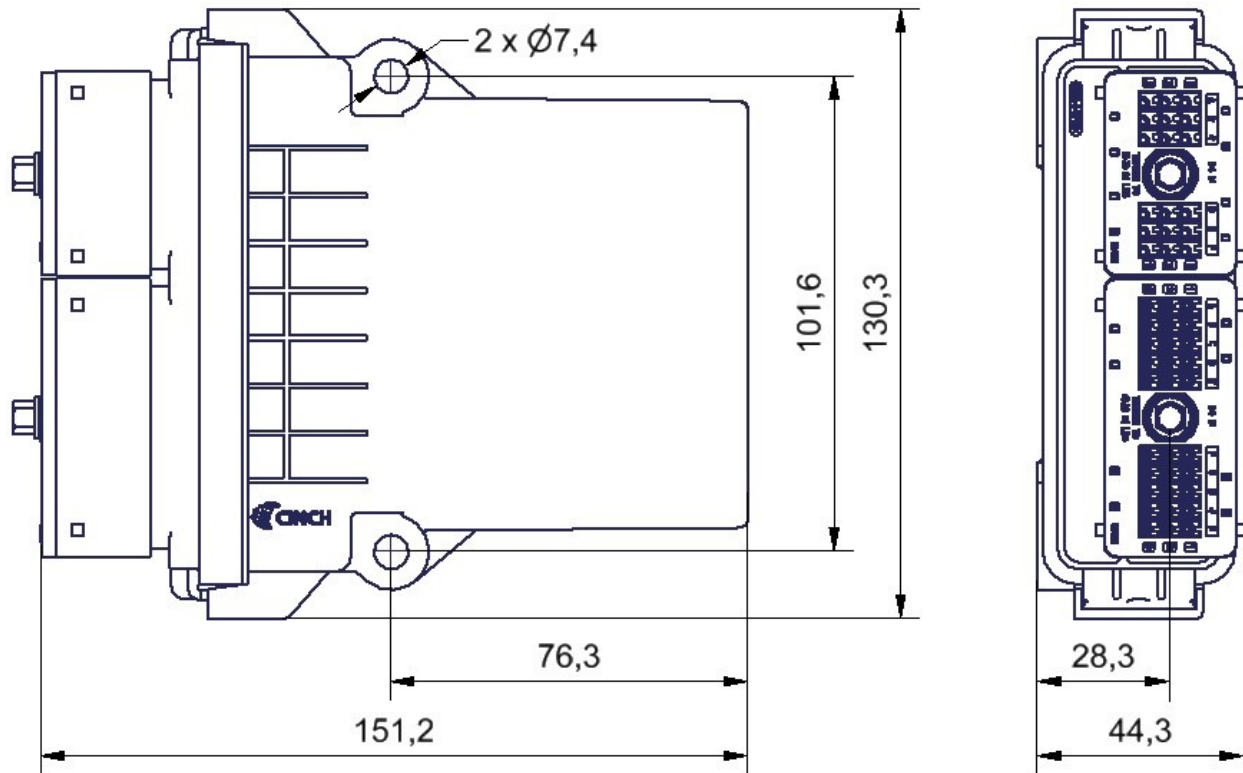

Note: The CAN terminating resistor can be activated in software, either by *using the GUI* (page 33) or by setting the corresponding flag in the *parameter set* (page 15).

The USBoard-USS5-IP can be mounted in any orientation.

1.4 Connector Descriptions

1.4.1 Connectors

1.4.1.1 Cinch ModICE ME



Pins	Cinch	Farnell	RS Components
30 pins, 3 rows	581 01 30 029	2751266	664-7267
18 pins, 3 rows	581 01 18 023	2751265	664-7254

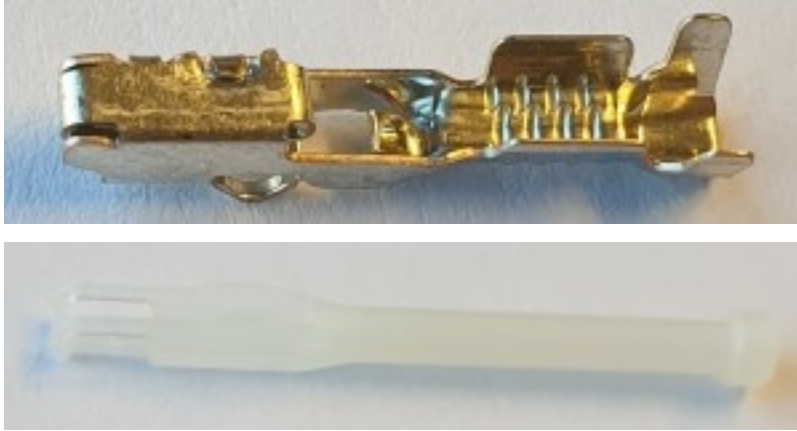

	Cinch	Farnell	RS Components
Crimp contacts AWG 20	425 00 00 872	2751652	885-7025
Blind plug	581 00 00 011	2751475	664-7295

1.4.2 Primary Connector

Pin	Description
1A	Ground (Sensors)
1B	Sensor 8
1C	Sensor 7
1D	Sensor 6
1E	Sensor 5
1F	CAN High
1G	CAN High
1H	Warning Relay Output (Normally Open)
1J	Alarm Relay Output (Normally Open)
1K	Ground (Supply)
2A	RS-232 RxD (Receive Line)
2B	Ground (Sensors)
2C	Ground (Sensors)
2D	Ground (Sensors)
2E	Ground (Sensors)
2F	CAN Low
2G	CAN Low
2H	Warning Relay Output (Normally Open)
2J	Alarm Relay Output (Normally Open)
2K	Supply Voltage
3A	RS-232 TxD (Transmit Line)
3B	Sensor Supply Voltage
3C	Sensor Supply Voltage
3D	Sensor Supply Voltage
3E	Sensor Supply Voltage
3F	Ground (Sensors)
3G	Sensor 4
3H	Sensor 3

Continued on next page

Table 1 – continued from previous page

Pin	Description
3J	Sensor 2
3K	Sensor 1

1.4.3 Secondary Connector

Pin	Description
1A	Sensor 16
1B	Sensor 15
1C	Not Connected
1D	Not Connected
1E	Sensor10
1F	Sensor9
2A	Ground (Sensors)
2B	Ground (Sensors)
2C	Sensor14
2D	Sensor12
2E	Ground (Sensors)
2F	Ground (Sensors)
3A	Sensor Supply Voltage
3B	Sensor Supply Voltage
3C	Sensor 13
3D	Sensor 11
3E	Sensor Supply Voltage
3F	Sensor Supply Voltage

1.5 Additional Parts

1.5.1 USBoard-USS5-IP Connectors

Note: An overview of the connectors for the USBoard-USS5-IP can be found at *Connector Descriptions* (page 4).

A complete connector set for the USBoard-USS5-IP can be ordered from Neobotix under order number X222 for customers who want to manufacture the cable set themselves.

1.5.2 USBoard-USS5-IP Configuration Cable

Neobotix offers a standard cable set (X221) for first tests of the USBoard-USS5-IP. This cable set features cables of 1 m length for up to four sensors. All other cables are also 1 m long.

The connection layout is as follows:

Connection	Pin	Description
1 x Red	+	Power
1 x Black	-	Ground
2 x Brown		Warning Relay
2 x Yellow		Alarm Relay
D-Sub 9 "RS-232"	2	Transmit Line (TxD)
	3	Receive Line (RxD)
	5	Ground
D-Sub 9 "CAN1"/"CAN2"	2	CAN Low
	3	CAN High
	7	CAN Ground

1.5.3 Primary Cable Set

We also offer a complete cable set for the 30 pin primary connector with order number X223. The basic cables are identical to the configuration cable. The only difference is that the primary cable set features eight sensor cables of 2 m each. Other cable lengths (up to 25 m) and designs are available on request.

1.5.4 Secondary Cable Set

Customers who want to use more than eight sensors can order our secondary cable set (X224). This provides another eight sensor cables of 2 m length. Other cable lengths (up to 25 m) and designs are available on request.

1.5.5 Sensors

The USBoard-USS5-IP uses the same sensors as the USBoard-USS5. You can find more information and the part numbers in its documentation at *Ultrasonic Sensors* (page 38).

1.6 Legal Notes

The general legal notes can be found at *Legal Notes* (page 49).

1.6.1 EU Declaration of Conformity



This product fulfils all relevant directives of the European Union.

1.6.2 RoHS Information



This product complies to the RoHS directives 2011/65/EU (RoHS 2) and 2015/863/EU of the European Parliament and the Council on the restriction of the use of hazardous substances in electrical and electronic equipment.

↓ Download as PDF²

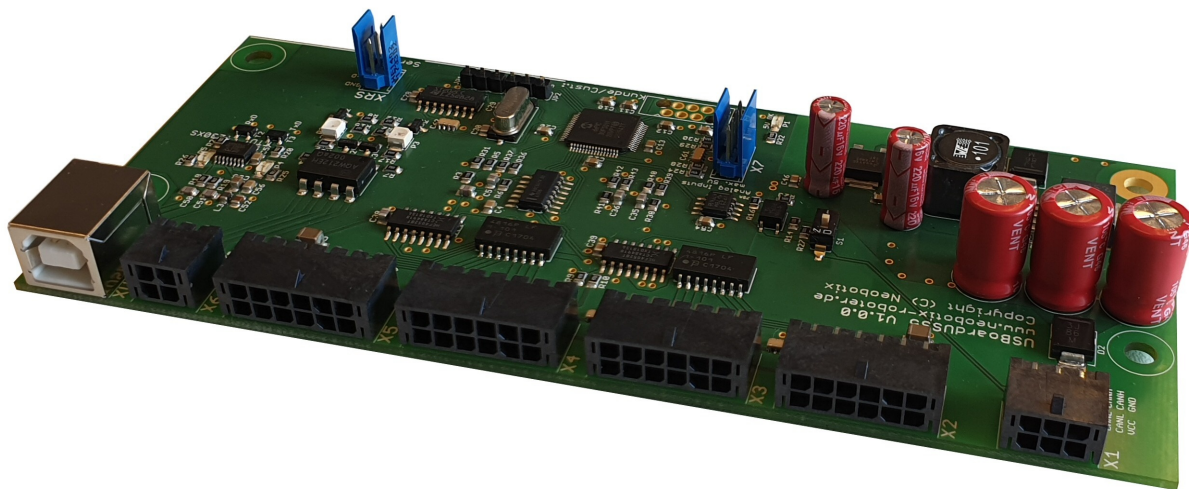

Ultrasonic sensors are used to measure the distance to objects within the sensor's metering range. The metering principle is based on measuring the time of flight of a sound pulse. This pulse is created by the sensor, reflected by an obstacle and then received by the sensor.

The USBoard-USS5 is capable of operating up to 16 ultrasonic sensors of type Bosch USS5. It can be used for collision detection on autonomous vehicles like mobile robot, wheeled drones and other AGVs. The board features easy commissioning, comfortable parametrization and a wide range of custom settings. Defining warning and alarm distances allows an easy detection of possible collisions.

Furthermore four analogue inputs are available on the board. These inputs can be used to add other sensors to the system without the need for any additional boards.

² <https://neobotix-docs.de/hardware/en/USBoard-USS5.pdf>

Tip: The Graphical User Interface for the USBoard-USS5 can be found at *Graphical User Interface* (page 28).

2.1 Introduction

See also our *FAQ* (page 41).

2.1.1 Intended Use

The USBoard-USS5 was designed for use in mobile robots and similar machines like wheeled drones or AGVs. It is meant for obstacle detection and collision avoidance.

The USBoard-USS5 can also be used in stationary machines or equipment to provide distance measurement data.

The USBoard-USS5 was developed to provide exclusively non-safe data and information.

2.1.2 Improper Use

The USBoard-USS5 is explicitly **not a safety device** and must not be used as such. It must never be used to safeguard dangerous areas or as single system for collision avoidance.

It is not recommended to use the USBoard-USS5 in applications with very high requirements on measurement accuracy, on reliability of the measurements or on data output speed. This for example includes motion control applications like parking.

2.1.3 Qualified Personnel

The USBoard-USS5 must only be installed, connected and brought into service by *qualified personnel* (page 48).

2.2 Operating Principle

2.2.1 Basic Principle

An ultrasonic sensor creates a sound pulse that is reflected by obstacles and then returns to the sensor. By measuring the time between emitting and receiving the ultrasonic pulse, the USBoard-USS5 is able to calculate the distance between the sensor and the closest obstacle.

In default mode the sensors are operated cyclically one after. In *cross echo mode* (page 11) the sensors operate in groups of four. Only one of these sensors emits the pulse but all sensors can receive the echo. If the geometric positions of the sensors are known it is possible to triangulate the position of the detected obstacle.

A CAN and a USB communication interface can be used to acquire distance data measured by the sensors as well as the data from the analogue inputs. On request the USB port can be replaced by a RS-232 interface.

For each sensor a warning and an alarm distance can be defined by software. This allows using the board for collision protection. As soon as the distance measured by a sensor falls below the according warning distance, an LED on the board lights up and a relay is switched. A second LED and another relay indicate that an obstacle was detected within the alarm distance of one or more sensors. Warning and alarm distances are defined in the parameter set via the GUI.

Warning: The USBoard-USS5 is no safety system and can only provide supporting, non-safe information. Never use the USBoard-USS5 for safeguarding of dangerous areas or movements.

2.2.2 Cross Echo Mode

In the traditional, sequential operation mode the sensors are independent from each other. They operate in an infinite loop one after the other, with each sensor sending its own ultrasonic pulse and waiting for the echo to calculate the distance to the object (left picture below). If a sensor receives an echo from a pulse that was sent earlier by another sensor it will be treated like a regular echo, resulting in a faulty measurement (right picture).

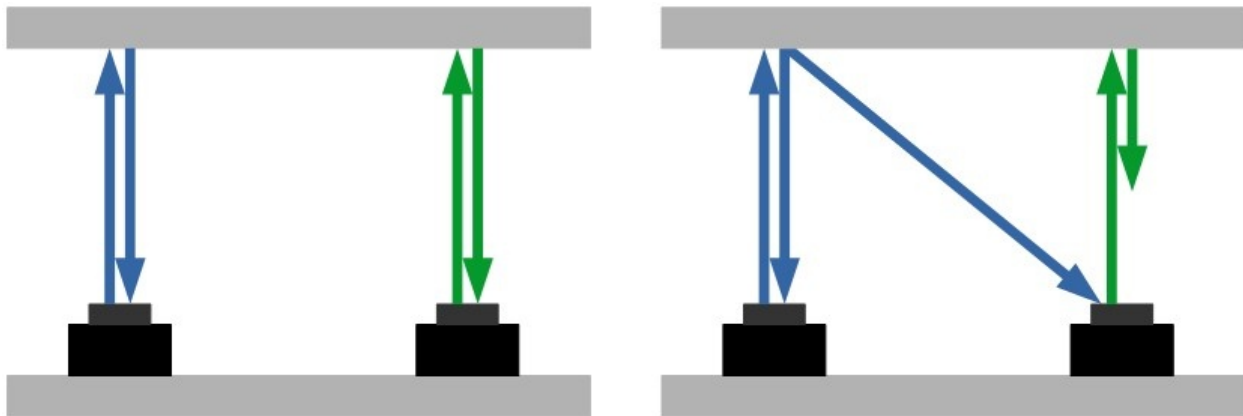

In cross-echo mode only one sensor of the group of four will send a pulse but all four sensors can receive the echo. If the positions of all sensors are known it is possible to estimate the location of the detected object based on the different durations it takes the echo to reach each sensor.

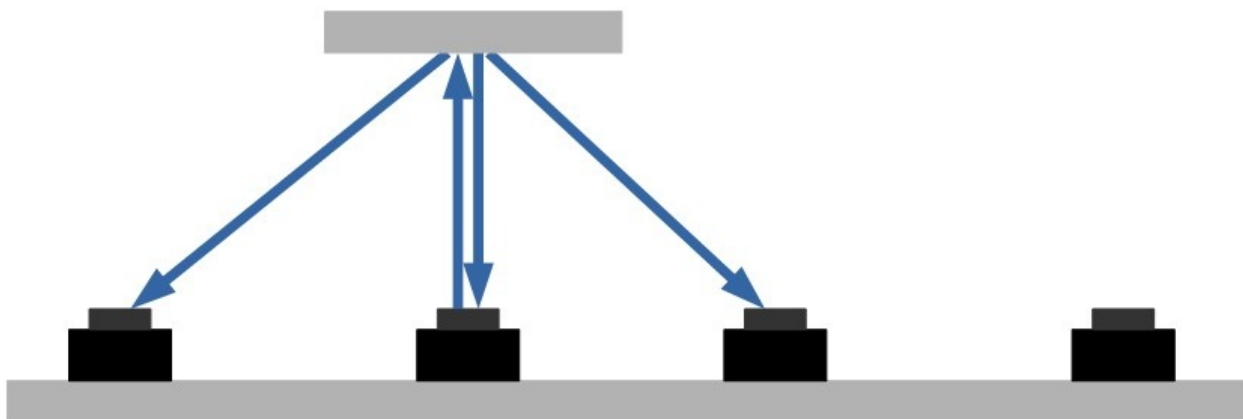

Several aspects should be kept in mind when calculating the object's position.

- Depending on the shape and surface of an object the ultrasound pulse is reflected or absorbed differently. This is why some objects may be detectable with direct measurements in normal mode but do not create a sufficiently strong cross-echo.
- The realistic field of view of the sensors is rather limited at large distances and also dependent on form and material of the object. It is thus recommended to do some experiments and tests in cross-echo mode before setting up the actual application.
- The distance calculation performed by the USBoard-USS5 is the same in both operating modes: The time between sending and receiving the echo is halved and multiplied with the speed of sound. This reduces processing

and cycle times and makes the data output easier. If the distance between the sensors of a cross-echo group is not too big this simplified calculation often provides usable results, despite being not perfectly accurate. For an exact triangulation please double the measurement output to get the total distance from the sending sensor to the obstacle and back to each sensor.

2.3 Technical Data

2.3.1 USBoard-USS5

- Supply voltage from +9 VDC up to +60 VDC, max. 4 W
- Digital communication via CAN and USB, optional RS-232
- Optical indicators for warning and alarm distance
- Solid state relay outputs for warning and alarm distance (max. 60 V, 0,5 A)
- Four analogue inputs (0 V – 5 V)
- Weight: 71 g
- Storage temperature range: -40 °C – 85 °C
- Operation temperature range: 0 °C – 70 °C
- Customs tariff number: 9031 9000
- Order number: X101

2.3.2 Ultrasonic Sensor Bosch USS5

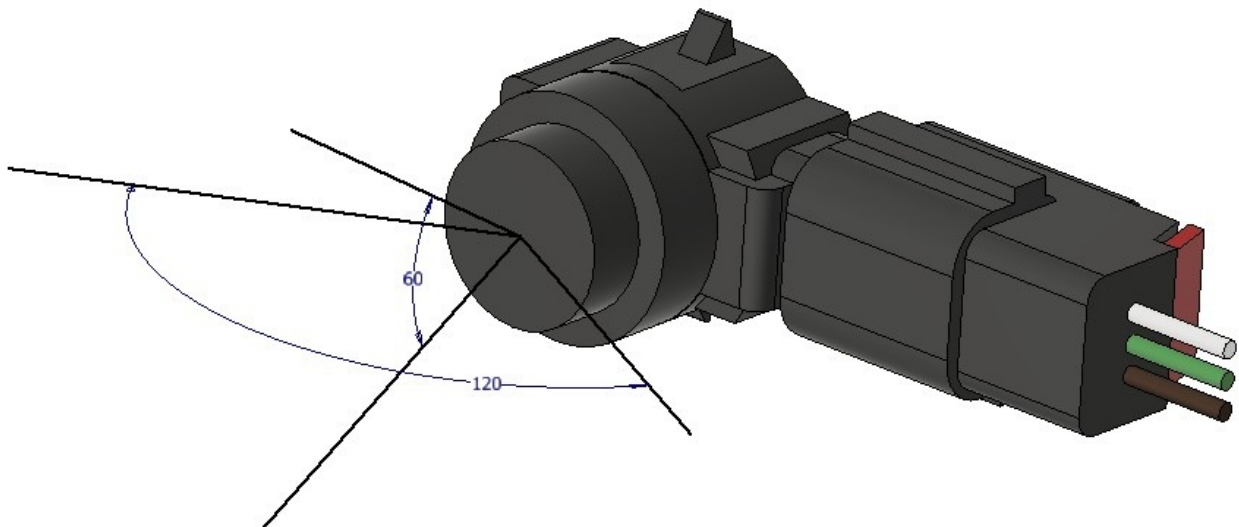

- Theoretical field of view: 120° x 60°, symmetrical
- Realistic field of view at maximum distance: 10° x 10°, symmetrical
- Please check our FOV test results *below* (page 13).
- Operating frequency: 48 kHz
- Range: 0.2 m up to 3.3 m

- Detection of objects closer than the minimum distance
- Indication of empty measurement range (no echo)
- Customs tariff number: 9031 8080
- Order number: X210

2.3.3 USS5 Field of View

We have tested the USS5 real world field of view with different objects and configurations. So far we did tests with

- a plastic tube (diameter 75 mm, height 1.75 m)
- a wooden bar (width 0.1 m, height 1.77 m)
- a cardboard rectangle (width 0.6 m, height 0.4 m)
- a human (height 1.8 m)

You can download our full data set [here](#).

Note: Please note that the data on this page are only for reference and are no assurance of any product features. Please perform your own tests to check the suitability of the USBoard-USS5 and the USS5 sensors for your specific application.

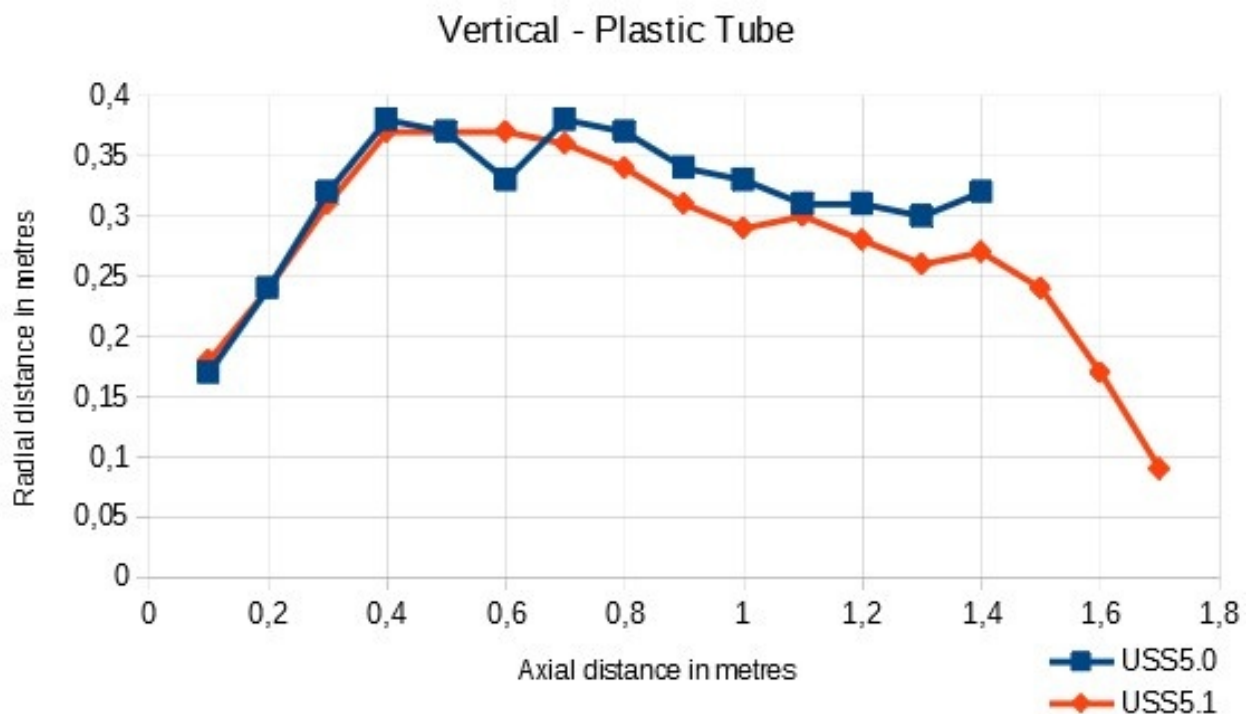

Vertical - Wooden Bar

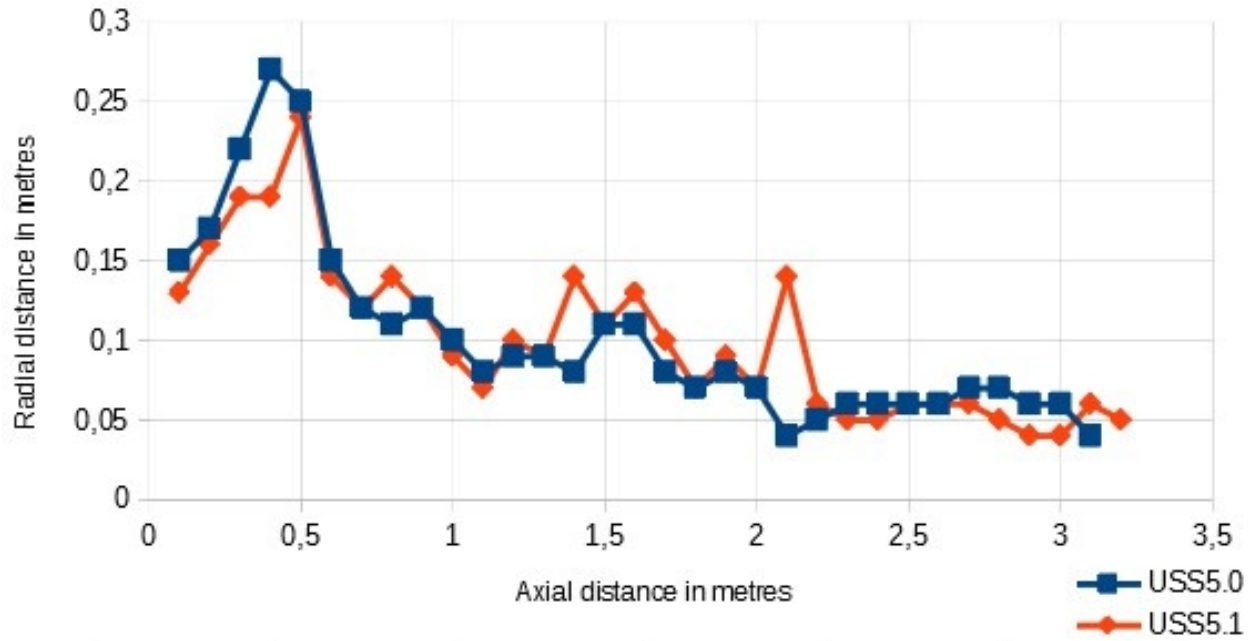

Vertical - Cardboard Rectangle

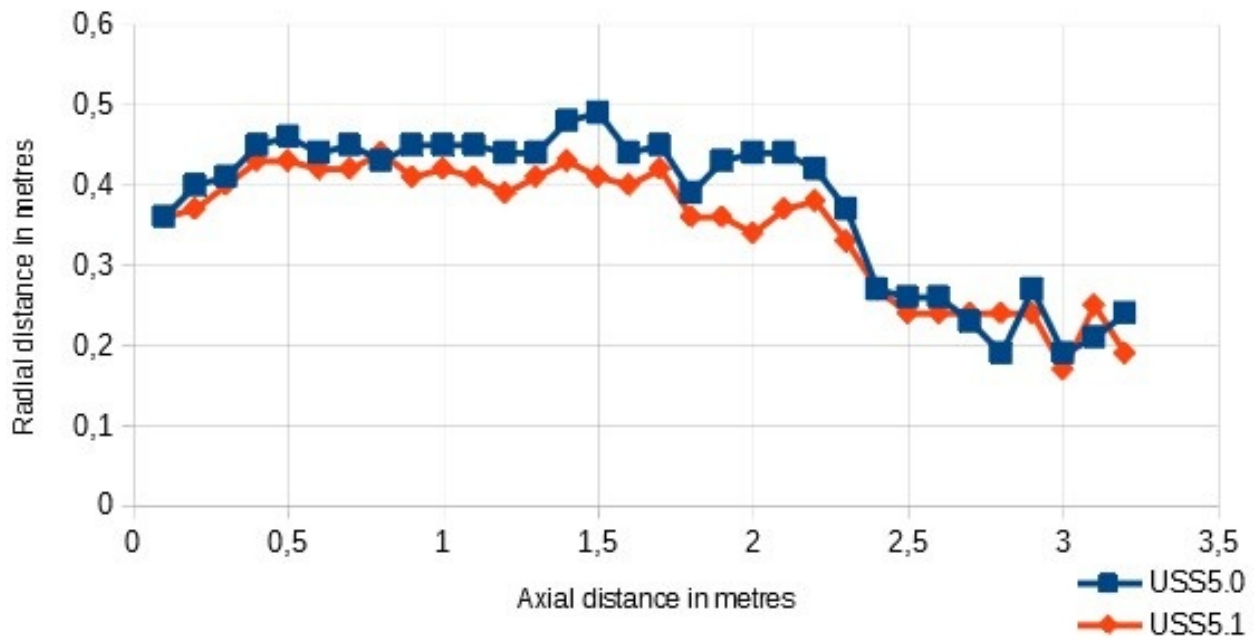

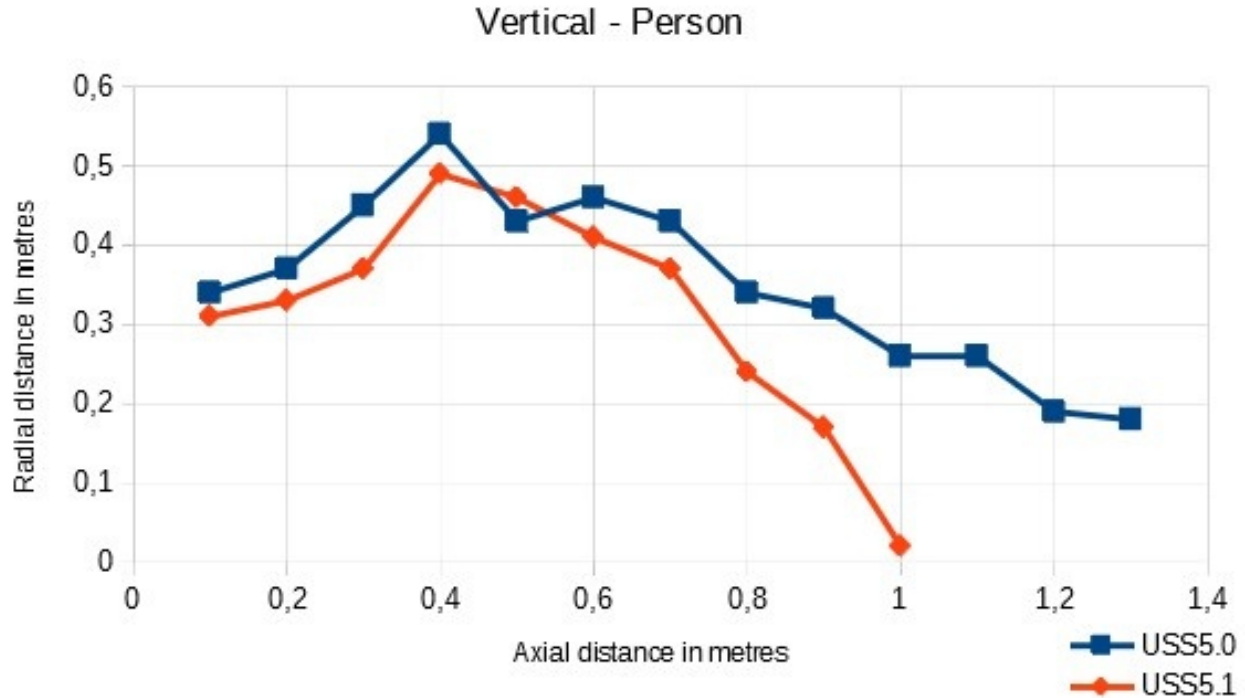

2.4 Parameter Set

The USBoard-USS5 uses a parameter set which allows a custom configuration. The graphical user interface can be used to easily manipulate the board's settings, store them on the host computer's hard drive, write them to the EEPROM on the USBoard-USS5 or read the current values from the board.

The parameter set consists of 54 bytes as described below.

Note: Several features affect groups of sensors. In these cases group 0 contains sensors 1 to 4, group 1 contains sensors 5 to 8 and so on.

Byte 0 CAN baud rate

0	1000 kBaud (default)
1	500 kBaud
2	250 kBaud
3	125 kBaud
4	100 kBaud
5	50 kBaud

Bytes 1-4 CAN base address (default $0x400$), calculated as follows:

$(\text{byte}_4 \ll 24) \mid (\text{byte}_3 \ll 16) \mid (\text{byte}_2 \ll 8) \mid \text{byte}_1$

Byte 5 Flags as bitmask

Bit	Meaning
0	Enable CAN extended id (default 0)
1	Enable CAN termination of USBoard-USS5-IP (default 0)
2	Enable analog input (default 0)
3	Enable legacy data format (default 0)
4	Warning relay blocked mode (default 0) (see <i>Configuration</i> (page 31))
5	Alarm relay blocked mode (default 0) (see <i>Configuration</i> (page 31))

In legacy mode, the data format is the same as the previous version of the USBoard, compatible to Relay-BoardV2. This only affects continous transmission mode.

Byte 6 Bits 0 to 3 encode the transmission mode for measurement data.

0	Send on request
1	Send continously via CAN
2	Send continously via USB / RS-232
3	Send continously via CAN and USB / RS-232

Bits 4 to 7 select which group will send measured data (bit 4 for group 0, bit 5 for group 1 and so on). If all bits are set to 0, all groups will send.

Default is 0xF0, i.e. all groups transmit on request.

Byte 7 Bits 0 to 3 encode the transmission interval when sending continously.

0	0.5 s
1	1.0 s
2	2.0 s
3	0.2 s
15	custom

Bits 4 to 7 encode a custom transmission interval in 50 ms increments (0 for 50 ms, 1 for 100 ms and so on).

Byte 8 Sensors 1 to 8 active, bit coded. Default is 0xFF, i.e. all active.

Deactivated sensors do not send ultrasonic pulses. Deactivating sensor channels that are not in use reduces the overall cycle time.

Byte 9 Sensors 9 to 16 active, bit coded. Default is 0xFF, i.e. all active.

Deactivated sensors do not send ultrasonic pulses. Deactivating sensor channels that are not in use reduces the overall cycle time.

Bytes 10-25 Warning distances of sensors 1-16, in cm. Default is 100 cm.

Bytes 26-41 Alarm distances of sensors 1-16, in cm. Default is 30 cm.

Byte 42 Sensor resolution, 2 bits per group

0	1 cm
1	0.5 cm (default)
2	0.25 cm
3	0.125 cm

Byte 43 Enable cross echo mode, one bit per group. Default is 0.

Byte 44 Cross echo configuration, 2 bits per group denoting the sending sensor (0 to 3). Default is 0, i.e. the first sensor in the group.

Bytes 45-46 Fire interval in increments of 10 ms, 4 bits per group (0 for 10 ms, 1 for 20 ms and so on). Default is 20 ms.

Byte 47 Low-pass filter gain (see below) for distance measurements, in 0.0078125 increments. Default is 128, i.e. gain 1, filtering disabled.

Byte 48 Reserved, set to arbitrary values when sending.

Byte 49 Hardware version, read only.

20	USBoard-USS5 V1.0.0
21	USBoard-USS5 V1.0.1
200	USBoard-USS5-IP V1.0.0
201	USBoard-USS5-IP V1.0.1

Bytes 50-53 Serial number, read only.

(In USBoard V1, only bytes 51-53 are used.)

The low pass filter feature can be used to smoothen the measurements and to prevent single, potentially faulty, readings from immediately switching the relays. Each new measurement of a sensor is added to the output value according to the filter's weight.

A setting of 0.3 means that the output is calculated from 70% of the previous output value and 30% of the new measurement.

A setting of 1.0 means that each new measurement is directly used as output value while the old value is discarded, in effect deactivating the filter.

2.5 Command Set

2.5.1 Command IDs

The following table shows the available commands of the USBoard-USS5.

Command	Value	Description
CMD_CONNECT	0	Check connection
CMD_SET_CHANNEL_ACTIVE	1	Activate channel for sending / receiving
CMD_GET_DATA_1TO8	2	Request data of sensors 1 to 8
CMD_GET_DATA_9TO16	3	Request data of sensors 9 to 16
CMD_WRITE_PARASET	4	Upload parameter set to board (volatile)
CMD_WRITE_PARASET_TO_EEPROM	5	Write parameter set to board's EEPROM (non-volatile)
CMD_READ_PARASET	6	Read current parameter set
CMD_GET_ANALOGIN	7	Read values of analogue inputs
-	8-12	Reserved
CMD_GET_DATA	13	Request data of all sensors

2.5.2 CAN Communication

The default base address is 0x400. This base address can be changed in the parameter set.

The addresses used by the USBoard-USS5 are calculated from the base address by adding the following offsets.

Offset to base address	Function
+0	Receive commands
+1	Answer to CMD_CONNECT
+2	First answer to CMD_GET_DATA_1TO8
+3	Second answer to CMD_GET_DATA_1TO8
+4	First answer to CMD_GET_DATA_9TO16
+5	2nd answer to CMD_GET_DATA_9TO16
+6	Answer to CMD_READ_PARASET
+7	Answer to CMD_GET_ANALOGIN
+8	Answer to CMD_WRITE_PARASET
+9	Answer to CMD_WRITE_PARASET_TO_EEPROM
+13	1st Answer to CMD_GET_DATA (group 0: 1 to 4)
+14	2nd Answer to CMD_GET_DATA (group 1: 5 to 8)
+15	3rd Answer to CMD_GET_DATA (group 2: 9 to 12)
+16	4th Answer to CMD_GET_DATA (group 3: 13 to 16)

2.5.3 USB / Serial Interface

Communication via USB is done via a USB-serial-converter on the USBoard-USS5. The computer's operating system can access it like a traditional serial interface. On request the USB converter can be replaced by an RS-232 transmitter. This does not affect the communication protocol of the serial interface.

Note: The RS-232 interface requires a common ground connection between the USBoard-USS5 and the computer.

The serial interface runs at 19200 Baud. Its protocol has the same format as the CAN communication except for the following addition:

Every message **from** the USBoard-USS5 begins with a start byte which must have the value 0xFF. After each message, made up of eight data bytes, a 16 bit checksum is sent. Because of this, a complete message is 11 bytes long.

Byte 1	Bytes 2-9	Byte 10	Byte 11
0xFF	data bytes	checksum high byte	checksum low byte

The checksum is calculated with an CRC-CCITT algorithm using 8 databytes.

Messages **to** the USBoard-USS5 only contain the data bytes.

Example implementation of the checksum calculation (C code):

```

unsigned int getChecksum(unsigned char *c, size_t iNumBytes) {
    unsigned int uCrc16;
    unsigned char ucData[2];
    size_t i;

    uCrc16 = 0;
    ucData[0] = 0;
    for(i=0; i<iNumBytes; i++){
        ucData[1] = ucData[0];
        ucData[0] = c[i];
    }
}

```

(continues on next page)

(continued from previous page)

```

        if(uCrc16 & 0x8000){
            uCrc16 = (uCrc16 & 0x7fff) << 1;
            uCrc16^= 0x1021;
        }else{
            uCrc16 <<= 1;
        }
        uCrc16^= ((unsigned int)(ucData[0]) | ((unsigned int)(ucData[1]) << 8));
    }

    return uCrc16;
}

```

2.6 Commands

You can find the command set at *Command Set* (page 17).

Note: Byte 0 in this documentation refers to the first data byte after the header. Individual bytes are transferred with the Least Significant Bit first.

In the following, the CAN IDs are given as an offset to the base address, so +3 means base address plus 3.

2.6.1 CMD_CONNECT

Use this command to establish and check the connection to the board.

Command ID: +0

CMD_CONNECT	0	0	0	0	0	0	0
-------------	---	---	---	---	---	---	---

Answer ID: +1

CMD_CONNECT	1	2	3	4	5	6	7
-------------	---	---	---	---	---	---	---

2.6.2 CMD_SET_CHANNEL_ACTIVE

This command can be used to activate or deactivate individual sensors without transmitting the complete parameter set. Two bytes for the channels 1 to 8 and 9 to 16 contain the information whether the sensors should be active. These bytes are bit-coded, each bit representing the state of one sensor. Every active channel is marked with a 1.

For example, $0 \times 1F$ as the first byte means channels 1 to 5 are active and channels 6 to 8 are not active.

Command ID: +0

CMD_SET_CHANNEL_ACTIVE	(Sensors 1 to 8)	(Sensors 9 to 16)	0	0	0	0	0
------------------------	------------------	-------------------	---	---	---	---	---

Answer No answer.

2.6.3 CMD_GET_DATA_1TO8

This command is used to request the readings of sensors 1 to 8.

Command ID: +0

CMD_GET_DATA_1TO8	0	0	0	0	0	0	0
-------------------	---	---	---	---	---	---	---

Answer (two parts) IDs: +2, +3

CMD_GET_DATA_1TO8	0	Values for sensors 1-4 (one byte each)	0	(reserved)
CMD_GET_DATA_1TO8	1	Values for sensors 5-8 (one byte each)	0	(reserved)

The measurement values are given according to the configured sensor group resolution (see *Parameter Set* (page 15)).

Note: This is a legacy command. The maximum value is 255 (1 Byte). Higher bits are not transmitted.

2.6.4 CMD_GET_DATA_9TO16

This command is used to request the readings of sensors 9 to 16.

Command ID: +0

CMD_GET_DATA_9TO16	0	0	0	0	0	0	0
--------------------	---	---	---	---	---	---	---

Answer (two parts) IDs: +4, +5

CMD_GET_DATA_9TO16	0	Values for sensors 9-12 (one byte each)	0	(reserved)
CMD_GET_DATA_9TO16	1	Values for sensors 13-16 (one byte each)	0	(reserved)

The measurement values are given according to the configured sensor group resolution (see *Parameter Set* (page 15)).

Note: This is a legacy command. The maximum value is 255 (1 Byte). Higher bits are not transmitted.

2.6.5 CMD_WRITE_PARASET

Use this command to transfer a complete parameter set to the USBoard-USS5. The parameters are stored volatile, which means that they will be lost when the board is switched off. To conveniently configure the board, use the graphical parameter editor.

After transmitting the parameter set, it will immediately be used by the board.

Command ID: +0

The command consists of nine messages sent one after the other, each containing some bytes of the parameter set.

CMD_WRITE_PARASET	0	Bytes 1 to 6
CMD_WRITE_PARASET	1	Bytes 7 to 12
CMD_WRITE_PARASET	2	Bytes 13 to 18
CMD_WRITE_PARASET	3	Bytes 19 to 24
CMD_WRITE_PARASET	4	Bytes 25 to 30
CMD_WRITE_PARASET	5	Bytes 31 to 36
CMD_WRITE_PARASET	6	Bytes 37 to 42
CMD_WRITE_PARASET	7	Bytes 43 to 48
CMD_WRITE_PARASET	8	Bytes 49 to 54

Answer ID: +8

Each message is answered individually. The first 8 answers are identical

CMD_WRITE_PARASET	0	0	0	0	0	0	0
-------------------	---	---	---	---	---	---	---

and the last answer contains the sum of the first 48 bytes in the parameter set.

CMD_WRITE_PARASET	low byte	high byte	0	0	0	0	0
-------------------	----------	-----------	---	---	---	---	---

2.6.6 CMD_WRITE_PARASET_TO_EEPROM

Use this command to write a complete parameter set into the board's EEPROM. The parameters are stored non-volatile, which means that they will be used again the next time the USBoard-USS5 is switched on. To comfortably configure the board, use the graphical parameter editor.

The parameter set will immediately be used after transmission.

Command ID: +0

The command works identically to *CMD_WRITE_PARASET* (page 20), the only difference is the use of the command byte `CMD_WRITE_PARASET_TO_EEPROM`.

Answer ID: +9

The answer is identical to the answers to *CMD_WRITE_PARASET* (page 20), the only difference is the use of the command byte `CMD_WRITE_PARASET_TO_EEPROM`.

2.6.7 CMD_READ_PARASET

Use this command to read a complete parameter set from the USBoard-USS5.

Command ID: +0

CMD_READ_PARASET	0	0	0	0	0	0	0
------------------	---	---	---	---	---	---	---

Answer ID: +6

The answer consists of nine messages sent one after the other, each containing some bytes of the parameter set.

CMD_READ_PARASET	0	Bytes 1 to 6
CMD_READ_PARASET	1	Bytes 7 to 12
CMD_READ_PARASET	2	Bytes 13 to 18
CMD_READ_PARASET	3	Bytes 19 to 24
CMD_READ_PARASET	4	Bytes 25 to 30
CMD_READ_PARASET	5	Bytes 31 to 36
CMD_READ_PARASET	6	Bytes 37 to 42
CMD_READ_PARASET	7	Bytes 43 to 48
CMD_READ_PARASET	8	Bytes 49 to 54

2.6.8 CMD_GET_ANALOGIN

Use this command to acquire the data of the four analog inputs.

Command ID: +0

CMD_GET_ANALOGIN	0	0	0	0	0	0	0
------------------	---	---	---	---	---	---	---

Answer ID: +7

Because the resolution of the on-board AD-converter is 12 bit, the first part of the answer is made up of the four low bytes. Bytes 5 and 6 contain the upper 4 bits of the four channels.

CMD_GET_ANALOGIN	low 8 bit channel 0	low 8 bit channel 1	low 8 bit channel 2	low 8 bit channel 3	high 4 bits of channel 0 and 1	high 4 bits of channel 3 and 4	0
------------------	---------------------	---------------------	---------------------	---------------------	--------------------------------	--------------------------------	---

2.6.9 CMD_GET_DATA

This command is used to request the readings of selected sensors. The selection is done by a bit mask where bit 0 stands for group 0, bit 1 stands for group 1 and so on. There will be one answer message per selected group.

Command ID: +0

CMD_GET_DATA	(selected groups)	0	0	0	0	0	0
--------------	-------------------	---	---	---	---	---	---

Answer ID: +(13 + group_id)

CMD_GET_DATA	(info)	lower 8 bit sensor 0	lower 8 bit sensor 1	lower 8 bit sensor 2	lower 8 bit sensor 3	high 4 bits of sensors 0 and 1	high 4 bits of sensors 3 and 4
--------------	--------	----------------------	----------------------	----------------------	----------------------	--------------------------------	--------------------------------

The *info* byte contains

- 2 bits encoding the group id (0 to 3)
- 2 bits encoding the sensor resolution (0 for 1 cm, 1 for 0.5 cm, 2 for 0.25 cm, 3 for 0.125 cm)
- 4 bits denoting the sending sensor, either 0xFF if all sensors are sending or the bit of the active sensor set to 1 for cross echo mode

The *lower 8 bit* byte of a sensor can also contain an error code:

- 0 indicates that the sensor is not physically connected to the USBoard-USS5.

- 1 indicates that an object is closer than the minimum range of the sensor.
- 2 indicates that the sensor is active and sending pulses but has not received any echo. It usually occurs when the object is too far.

2.7 ROS Node

This node handles the communication of the Neobotix USBoard-USS5.

The USBoard-USS5 node has been tested with:

- ROS Kinetic on Ubuntu 16.04
- ROS Melodic on Ubuntu 18.04
- ROS Noetic on Ubuntu 20.04

Find the code of the ROS node at https://github.com/neobotix/neo_usboard_v2.

2.7.1 Installation

1. Clone the `neo_usboard_v2` repository into your catkin workspace source folder:

```
cd your_catkin_workspace/src
git clone https://github.com/neobotix/neo_usboard_v2.git
```

2. Clone `neo_msgs` into your catkin workspace source folder:

```
git clone https://github.com/neobotix/neo_msgs.git
```

3. Fetch the submodules: `vnx-base`, `pilot-base` and `pilot-usboard`:

```
cd neo_usboard_v2
git submodule update --init
```

4. Install `vnx-base` onto your system.

- ROS Kinetic:

```
sudo dpkg -i vnx-base/x86_64/vnx-base-1.9.3-x86_64-ubuntu-16.04.deb
```

- ROS Melodic:

```
sudo dpkg -i vnx-base/x86_64/vnx-base-1.9.3-x86_64-ubuntu-18.04.deb
```

- ROS Noetic:

```
sudo dpkg -i vnx-base/x86_64/vnx-base-1.9.3-x86_64-ubuntu-20.04.deb
```

5. Compile your workspace:

```
cd your_catkin_workspace
catkin_make
```

2.7.2 Launch

In case of using CAN, the bus needs to be configured first:

```
sudo ip link set can0 down
sudo ip link set can0 type can bitrate 1000000
sudo ip link set can0 up
```

To launch the USBoard-USS5 ROS node use:

```
roslaunch neo_usboard_v2 neo_usboard_v2.launch
```

2.7.3 Parameters

The following parameters can be changed according to your needs in `neo_usboard_v2.yaml`:

Parameter	Value	Note
<code>can_id</code>	1024	Needs to be a multiple of 32.
<code>can_device</code>	None or <code>can0</code>	
<code>serial_port</code>	<code>/dev/ttyUSB0</code>	
<code>can_baud_rate</code>	1000000 (bit/s)	Needs to match what is configured on the board.
<code>update_rate</code>	5 (Hz)	Relevant only in transmit mode “Request”, see USBoardV2 GUI.

Note: If `can_device` is set, the CAN bus will be used for communication, otherwise the serial interface specified in `serial_port` is used.

The following parameters can be changed from the parameter server once the ros node is executed.

Parameter	Value	Note
<code>low_pass_gain</code>	1	low pass filter gain (1 = no filtering)
<code>enable_analog_input</code>	false	if to enable reading analog inputs
<code>enable_legacy_format</code>	false	if to use old message format (when transmitting automatically)
<code>enable_can_termination</code>	false	if to connect CAN bus termination resistance on the board
<code>relay_warn_blocked_invert</code>	false	if to invert warn relay output when a sensor is blocked
<code>relay_alarm_blocked_invert</code>	false	if to invert alarm relay output when a sensor is blocked
<code>active_sensors(0 to 15)</code>	true	Active sensors from 1-16
<code>warn_distance(0 to 15)</code>	100 cm	Warning distances of sensors 1-16
<code>alarm_distance(0 to 15)</code>	30 cm	Alarm distances
<code>enable_transmission(0 to 4)</code>	true	if the group transmits in continuous mode
<code>fire_interval_ms</code>	20 ms	time between pulses
<code>sending_sensor</code>	0	index of the sensor which will send the pulse (cross echo mode)
<code>cross_echo_mode</code>	false	if to enable cross echo mode

Note: For setting the ros parameters from the application, it is advised to utilize the `/usboard_v2/set_parameters` service. If it is required to set the parameters from the command line, then please utilize the `roslaunch dynamic_reconfigure dynparam set param value` command to configure it. Please use the command `ros param list` to see the available parameters.

2.7.4 Topics

The following ROS topics are available:

Name	Type
/usboard_v2/measurements	neo_msgs/msgs/USBoardV2
/usboard_v2/sensor1	sensor_msgs/Range
/usboard_v2/sensor2	sensor_msgs/Range
...	
/usboard_v2/sensor16	sensor_msgs/Range

2.7.5 Multiple USBoards

In case of using multiple USBoard-USS5 simultaneously, it is possible to start multiple ROS nodes, one for each board.

2.7.5.1 Parameters

Each ROS node needs its own yaml configuration file, see for example `neo_usboard_v2.yaml` and `neo_usboard_v2_1.yaml` in https://github.com/neobotix/neo_usboard_v2/tree/main/launch:

```
can_id: 1024
can_device: None
#can_device: can0
serial_port: /dev/ttyUSB0
can_baud_rate: 1000000
update_rate: 5
topic_path: /usboard_v2
```

```
can_id: 1056
can_device: None
#can_device: can1
serial_port: /dev/ttyUSB1
can_baud_rate: 1000000
update_rate: 5
topic_path: /usboard_v2_1
```

Note: CAN IDs need to be a multiple of 0x20, ie. 32 in decimal.

2.7.5.2 Launching Multiple ROS Nodes

The standard launch file `neo_usboard_v2.launch` contains an example on how to start another ROS node:

```
<?xml version="1.0"?>
<launch>
  <!-- Load usboard_v2 params -->
  <rosparam command="load" ns="usboard_v2" file="$(find neo_usboard_v2)/launch/neo_
↪usboard_v2.yaml"/>
  <!-- start usboard_v2 node -->
  <node pkg="neo_usboard_v2" type="neo_usboard_v2" ns="usboard_v2" name="usboard_v2_
↪node" respawn="false" output="screen"/>
```

(continues on next page)

(continued from previous page)

```

<!-- Load usboard_v2 params for second board -->
<rosparam command="load" ns="usboard_v2_1" file="$(find neo_usboard_v2)/launch/
↪neo_usboard_v2_1.yaml"/>
<!-- start usboard_v2 node for second board -->
<node pkg="neo_usboard_v2" type="neo_usboard_v2" ns="usboard_v2_1" name="usboard_
↪v2_node_1" respawn="false" output="screen"/>
</launch>

```

Simply uncomment the second block to enable a second ROS node.

To launch all configured nodes:

```
roslaunch neo_usboard_v2 neo_usboard_v2.launch
```

2.7.6 Help

If you receive the error unable to connect to port /dev/ttyUSB0, run the following command:

```
sudo usermod -a -G dialout $USER
```

and restart your PC.

2.8 ROS 2 Node

This node handles the communication of the Neobotix USBoard-USS5.

The USBoard-USS5 node has been tested with:

- ROS 2 Foxy on Ubuntu 20.04, Rolling and Humble on Ubuntu 22.04

Find the code of the ROS node at https://github.com/neobotix/neo_usboard_v2-2.

Note: We also have extended our support to Galactic and Humble. Please checkout to the corresponding branch as needed.

2.8.1 Installation

1. Clone the neo_usboard_v2 repository into your catkin workspace source folder:

```
cd your_colcon_workspace/src
git clone https://github.com/neobotix/neo_usboard_v2-2.git
```

2. Clone neo_msgs into your catkin workspace source folder:

```
git clone https://github.com/neobotix/neo_msgs2.git
```

3. Fetch the submodules vnx-base, pilot-base and pilot-usboard:

```
cd neo_usboard_v2-2
git submodule update --init
```

4. Install vnx-base onto your system.

- ROS Foxy:

```
sudo dpkg -i vnx-base/x86_64/vnx-base-1.9.3-x86_64-ubuntu-20.04.deb
```

5. Compile your workspace:

```
cd your_catkin_workspace
colcon build --symlink-install
. install/setup.bash
```

2.8.2 Launch

In case of using CAN, the bus needs to be configured first:

```
sudo ip link set can0 down
sudo ip link set can0 type can bitrate 1000000
sudo ip link set can0 up
```

To launch the USBoard-USS5 ROS node use:

```
ros2 launch neo_usboard_v2 neo_usboard_v2.launch.py
```

2.8.3 Parameters

The following parameters can be changed according to your needs in `neo_usboard_v2.yaml`:

Parameter	Value	Note
<code>can_id</code>	1024	Needs to be a multiple of 32.
<code>can_device</code>	None or <code>can0</code>	
<code>serial_port</code>	<code>/dev/ttyUSB0</code>	
<code>can_baud_rate</code>	1000000 (bit/s)	Needs to match what is configured on the board.
<code>update_rate</code>	5 (Hz)	Relevant only in transmit mode “Request”, see USBoardV2 GUI.

Note: If `can_device` is set, the CAN bus will be used for communication, otherwise the serial interface specified in `serial_port` is used.

The following parameters can be changed from the parameter server once the `ros2` node is executed.

Parameter	Value	Note
low_pass_gain	1	low pass filter gain (1 = no filtering)
enable_analog_input	false	if to enable reading analog inputs
enable_legacy_format	false	if to use old message format (when transmitting automatically)
enable_can_termination	false	if to connect CAN bus termination resistance on the board
relay_warn_blocked_invert	false	if to invert warn relay output when a sensor is blocked
relay_alarm_blocked_invert	false	if to invert alarm relay output when a sensor is blocked
active_sensors(0 to 15)	true	Active sensors from 1-16
warn_distance(0 to 15)	100 cm	Warning distances of sensors 1-16
alarm_distance(0 to 15)	30 cm	Alarm distances
enable_transmission(0 to 4)	true	if the group transmits in continuous mode
fire_interval_ms	20 ms	time between pulses
sending_sensor	0	index of the sensor which will send the pulse (cross echo mode)
cross_echo_mode	false	if to enable cross echo mode

2.8.4 Topics

The following ROS topics are available:

Name	Type
/usboard_v2/measurements	neo_msgs/msg/USBoardV2
/usboard_v2/sensor1	sensor_msgs/msg/Range
/usboard_v2/sensor2	sensor_msgs/msg/Range
...	
/usboard_v2/sensor16	sensor_msgs/msg/Range

2.8.5 Help

If you receive the error unable to connect to port `/dev/ttyUSB0`, run the following command:

```
sudo usermod -a -G dialout $USER
```

and restart your PC.

2.9 Graphical User Interface

Download the GUI here: [Windows³](#), [Linux⁴](#)

2.9.1 Introduction

The USBoard-USS5 comes with a graphical user interface (GUI). This program can be used to configure the USBoard-USS5 for the application it will be used in. It also displays the current sensor readings and helps in setting up the system.

³ https://neobotix-docs.de/files/USBoardUSS5-GUI_Windows.zip

⁴ https://neobotix-docs.de/files/USBoardUSS5-GUI_Linux.zip

The USBoard-USS5-GUI requires a PC with a Microsoft Windows® or Ubuntu LTS operating system and a free USB port. For industrial applications the USB connection can be replaced with a RS-232 interface. In this case the computer will need an RS-232 interface (COM port) as well or a USB-Serial-Converter.

In Windows, the GUI comes with an installer. Just execute it with a double click and follow the instructions. The process should create a shortcut on your desktop that you can double click to start the GUI.

The Linux version comes with Debian packages for the latest Ubuntu LTS versions. Install the appropriate package with:

```
sudo dpkg -i the_right_package.deb
```

where you replace `the_right_package` with the one that fits your operating system. To run the GUI after the installation, please use the following command:

```
/opt/neobotix/usboard2-gui/bin/usboard2_gui
```

2.9.2 First Steps

2.9.2.1 The GUI Layout

The graphical user interface is divided into three main areas: the main functions area at the top, the central data area and the footer.

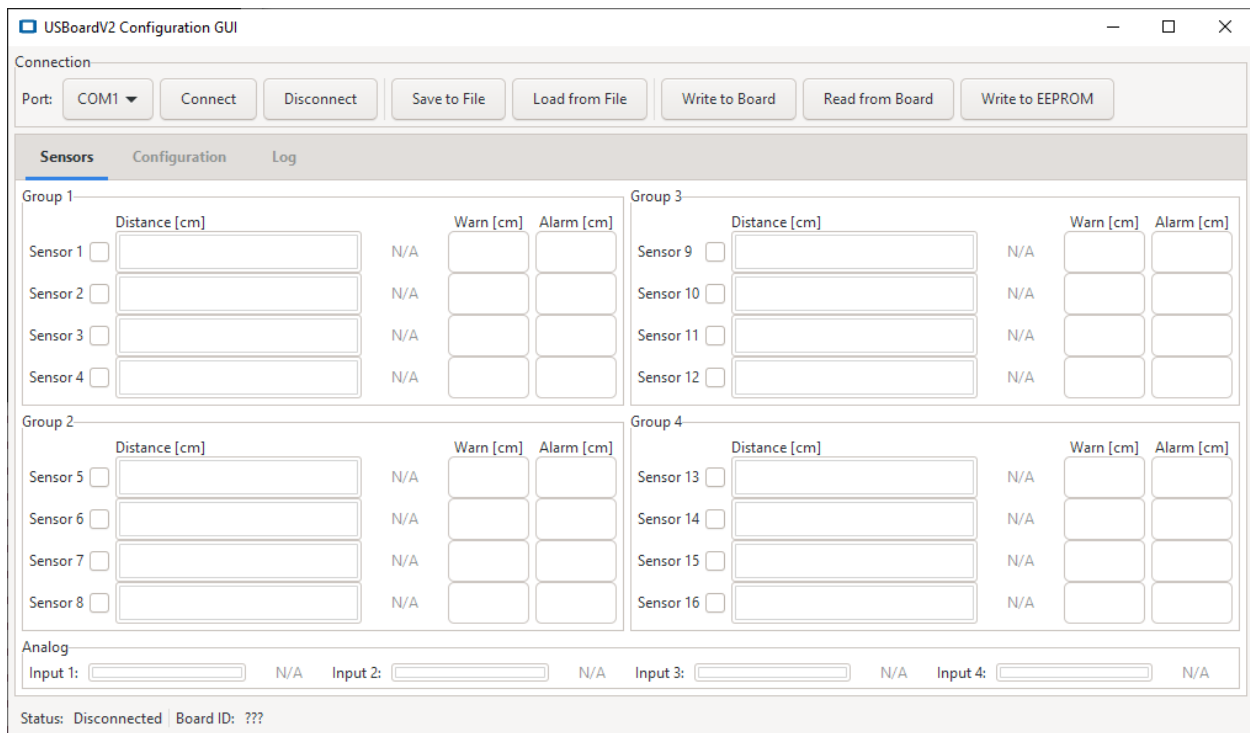

The Functions Area

The functions area is divided into three groups.

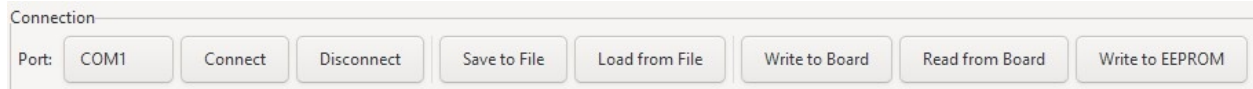

On the left you can find the basic functions to establish a connection to the USBoard-USS5 and also to disconnect again.

Port: Here you can select the interface that will be used to communicate with the USBoard-USS5. When plugging in the USB cable the operating system will automatically add a virtual COM port that can be selected here.

Connect Opens the selected interface and establishes a connection to the USBoard-USS5.

Disconnect Closes an open connection to a board.

Use the buttons in the central group to save the current USBoard-USS5 configuration into a file on your local computer or to load a configuration from such a file.

Save to File Saves the configuration from the GUI into a file on your computer.

Load from File Loads a configuration file and changes the GUI settings accordingly.

On the right you can find the buttons to transfer the current settings from the GUI to the USBoard-USS5 and to read the board's configuration into the GUI.

Write to Board Transfers the parameters to the volatile memory of the USBoard-USS5. After the next restart, the old parameters from the non-volatile memory will be used again.

Read from Board Reads the current configuration from the USBoard-USS5 and displays it in the GUI.

Write to EEPROM Writes the parameters into the non-volatile memory of the USBoard-USS5. These settings will be activated after a restart of the board.

The Data Area

The central data area features three different views that can be activated by clicking on the three tabs on top.

Sensors This view visualises the readings of the active sensors and displays their warning and alarm thresholds.

Configuration Here you can adjust the communication parameters and configure the sensors' behaviour.

Log The log lists system messages related to certain events.

The Footer

The footer displays the current connection state and the serial number of the board that the GUI is currently connected to.

2.9.2.2 Visualizing Measurements

Ultrasonic Sensors

The ultrasonic sensors are grouped by four, with each group being displayed in its own box within the data area.

Group 1

	Distance [cm]		Warn [cm]	Alarm [cm]
Sensor 1 <input type="checkbox"/>		N/A		
Sensor 2 <input type="checkbox"/>		N/A		
Sensor 3 <input type="checkbox"/>		N/A		
Sensor 4 <input type="checkbox"/>		N/A		

The check boxes next to the sensor numbers indicate whether a sensor is active. Only active sensors are triggered and read by the USBoard-USS5.

Tip: Deactivating sensor channels that are not in use will reduce the cycle time for reading all sensors and update measurements faster. Deactivated channels will be skipped by the USBoard-USS5 without waiting for an echo.

The warning and alarm thresholds of each sensor are displayed on the far right. The current distance measurements are shown as coloured bars and numerical values in the centre of the box.

Note: The USS5 sensors have an upper and a lower *measurement limit* (page 12). If an object is detected closer than the lower limit the message “BLOCKED” is shown instead of the measurement value. If no object can be detected within the measurement range at all the message “TOO FAR” will be shown.

Analogue Inputs

Analog

Input 1: <input type="text"/>	N/A	Input 2: <input type="text"/>	N/A	Input 3: <input type="text"/>	N/A	Input 4: <input type="text"/>	N/A
-------------------------------	-----	-------------------------------	-----	-------------------------------	-----	-------------------------------	-----

The measurements of the analogue inputs can be found below the ultrasonic sensor display. The analogue input values are also shown both as numerical value and as bars. The bars indicate the ratio of the current input voltage relative to the *maximum input voltage* (page 12).

2.9.3 Configuration

2.9.3.1 Basic Features

Sensor Configuration

The basic settings of the ultrasonic sensors can be changed right in the main measurement view.

Group 1		Distance [cm]		Warn [cm]	Alarm [cm]
Sensor 1	<input type="checkbox"/>	<input type="text"/>	N/A	<input type="text"/>	<input type="text"/>
Sensor 2	<input type="checkbox"/>	<input type="text"/>	N/A	<input type="text"/>	<input type="text"/>
Sensor 3	<input type="checkbox"/>	<input type="text"/>	N/A	<input type="text"/>	<input type="text"/>
Sensor 4	<input type="checkbox"/>	<input type="text"/>	N/A	<input type="text"/>	<input type="text"/>

Activation

Set the tick in the checkbox to activate the according sensor. Deactivated sensors will not be triggered by the USBoard-USS5, will not send an ultrasonic pulse and the board will not wait for an echo.

Tip: Deactivate all channels that are not in use. This will reduce the cycle time for handling all sensors and provide updated measurements as fast as possible.

If a sensor is not physically connected to the USBoard-USS5 but is marked as active the GUI will indicate this case by displaying “N/A” instead of a measurement value.

Thresholds

Every sensor has one warning and one alarm threshold. As soon as any active sensor measures a distance that is below the threshold the corresponding relay will be switched. The relays remain in active state as long as the measurement of at least one sensor is below its associated limit. Setting a threshold value of 0 will deactivate the function for this sensor.

Only integer values are accepted, indicating the distance in centimetres.

Handling Configurations

You can use the buttons in the functions area to save configurations to your local computer or to reuse them later. When connected you can also transfer a new configuration to a USBoard-USS5 or read the current one from the board.

Connection								
Port:	COM1	Connect	Disconnect	Save to File	Load from File	Write to Board	Read from Board	Write to EEPROM

Most of these functions are self-explanatory but some details should be kept in mind.

- Whenever you transfer a configuration (from file to GUI, from GUI to USBoard-USS5 or the other way round) the data on the receiving end will be overwritten. There is no Undo function.
- Use Write to Board to quickly test new settings. After restarting the USBoard-USS5 these changes will be lost and the configuration from the EEPROM memory will be used instead.
- Using Write to EEPROM stores the configuration in the non-volatile memory and also applies it immediately.
- Read from Board will only read the settings that are currently in use. These may differ from the configuration stored in the EEPROM.

2.9.3.2 Advanced Features

Please select the tab `Configuration` to change the view in the data area.

The screenshot shows a configuration interface with a top navigation bar containing 'Sensors', 'Configuration' (selected), and 'Log'. Below the navigation bar, there are five panels: 'Global' and four sensor groups labeled 'Group 1' through 'Group 4'. The 'Global' panel includes fields for 'CAN ID', 'CAN Baudrate', 'Transmit Mode', 'Update Interval', 'Low-Pass Gain', and checkboxes for 'CAN Termination', 'Enable Analog-In', 'Legacy Format', 'Warn Relay Mode', and 'Alarm Relay Mode'. Each sensor group panel includes dropdown menus for 'Resolution', 'Fire Interval', and 'Sender', and checkboxes for 'Transmit' and 'Cross-Echo'.

Global Settings

The box `Global` on the left contains communication and general settings.

CAN ID The base address of the USBoard-USS5 for CAN bus communication.

CAN Baudrate The CAN bus data rate.

Transmit Mode Sets the output mode of the board. Request means that the USBoard-USS5 will only send messages on request. In all other settings it will send out messages automatically via the selected interface.

Update Interval Defines the cycle time for sending messages in automatic sending mode.

Low-Pass Gain The low pass filter feature can be used to smoothen the measurements and to prevent single, potentially faulty, readings from immediately switching the relays. Each new measurement of a sensor is added to the output value according to the filter's weight. A setting of 0.3 means that the output is calculated from 70% of the previous value and 30% of the new measurement. A setting of 1.0 means that each new measurement is directly used as output value while the old value is discarded, in effect deactivating the filter.

CAN Termination In case of the USBoard-USS5-IP the CAN bus terminating resistor can be activated here. This parameter is without function in the normal USBoard-USS5.

Enable Analog-In Activates the use of the four analogue inputs. If your application requires very short cycle times and does not use these inputs it is recommended to disable the analogue inputs completely.

Legacy Format Enables the use of the USBoard V1 protocol. This makes the USBoard-USS5 compatible to older applications but disables some features.

Warn Relay Mode When checked, blocked sensors do not affect the warning relay, which can still be switched by the remaining functional sensors. Use this mode only if blocked sensors do not reduce the operational safety of your system. If unchecked, the warning relay is switched on as soon as a single sensor is blocked, regardless of the readings measured by the other sensors. Use this mode to indicate all cases of blocked sensors.

Alarm Relay Mode Equivalent to Warn Relay Mode but affecting the alarm relay.

Sensor Group Settings

The ultrasonic sensors are grouped in sets of four sensors each. The settings in this area always apply to all sensors of a group. Different groups can have completely different configurations.

Group 1

Resolution:	<input type="text"/>
Fire Interval:	<input type="text"/>
Sender:	<input type="text"/>
Transmit:	<input type="checkbox"/>
Cross-Echo:	<input type="checkbox"/>

Resolution The measurement data can be sent in four different resolutions: 1 cm, 0.5 cm, 0.25 cm or 0.125 cm.

Fire Interval The time between firing two sensors can be adjusted to avoid unwanted echos from earlier pulses. The minimum time a sensor needs to send a pulse and evaluate the echo is 10 ms. The minimum firing interval of 10 ms offers the fastest cycle time and is designed for a relatively short distance detection up to 150 cm. When the object is placed at a distance of more than 150 cm, there is not enough time for the sensor to receive the reflected echo within 10 ms. To provide enough time for the reflected echo to be received by the sensor at the maximum distance the default firing interval is 20 ms.

Sender If the group operates in cross-echo mode the pulse sending sensor can be selected here.

Transmit Includes the group into the data output.

Cross-Echo Switches the group from normal, sequential operation mode to cross-echo mode.

2.10 Dimensions

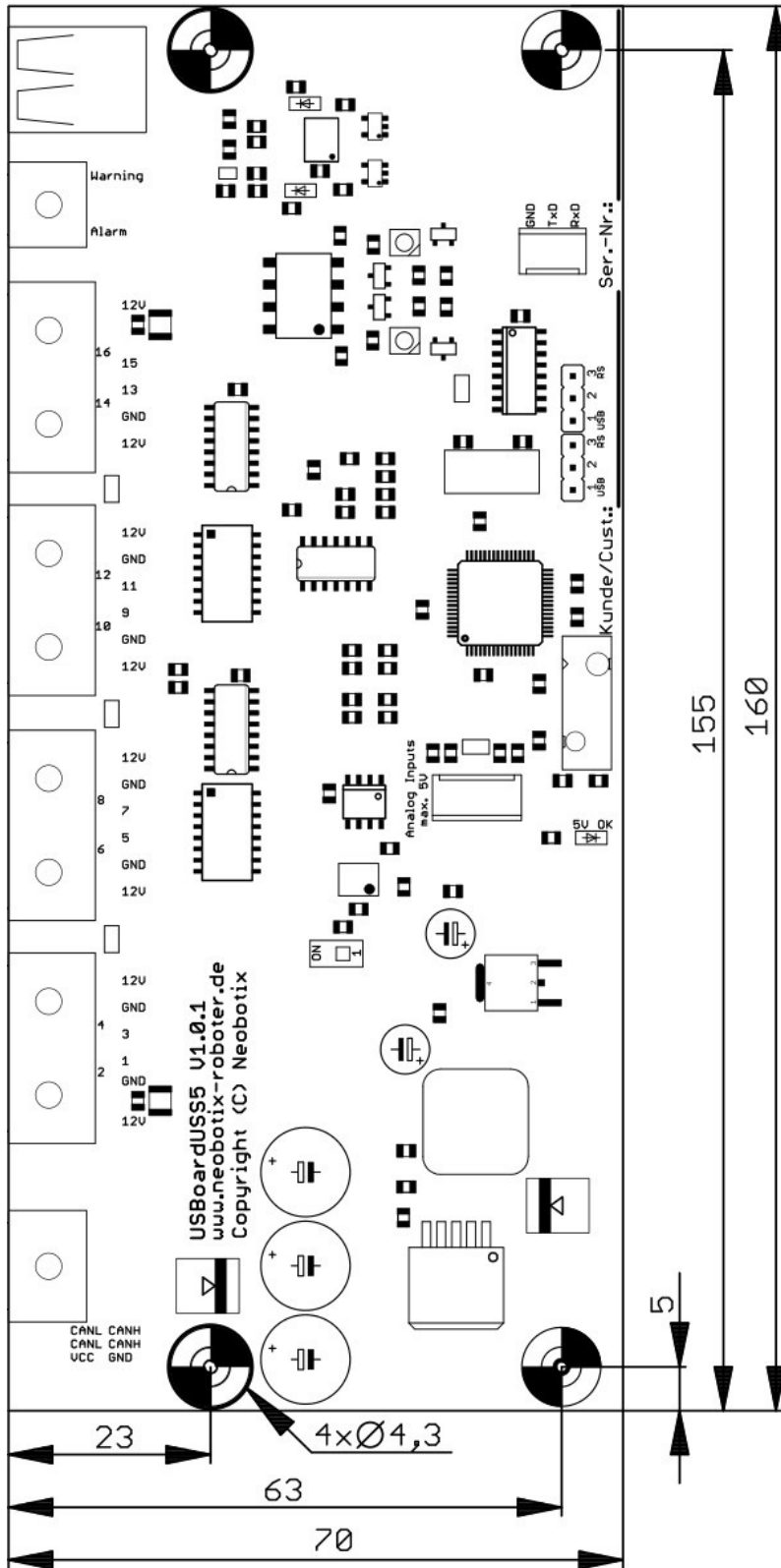

Note: Move S1 to position ON to activate the CAN terminating resistor.

Attention: The mounting holes near the supply connector X1 are electrically connected to the ground plane of the USBoard-USS5. Please insulate this mounting point if necessary in your installation.

The USBoard-USS5 can be mounted in any orientation.

2.11 Connector Descriptions

Note: More information about these connectors can be found at [Connectors](#) (page 44).

2.11.1 X1

Würth Elektronik MPC3, 2 rows, 6 pins

Pin	Description
1	Power Supply Input
2	CAN High
3	CAN High
4	Ground
5	CAN Low
6	CAN Low

Pins 2 and 3 are bridged, as well as pins 5 and 6. This allows two CAN cables (CAN-in and CAN-out) to be connected easily.

2.11.2 X2 - X5

Würth Elektronik MPC3, 2 rows, 12 pins

Pin	Description
1	Sensor supply voltage
2	Ground
3	Sensor data line (X2: Sensor 2, X3: Sensor 6, X4: Sensor 10, X5: Sensor 14)
4	Sensor data line (X2: Sensor 4, X3: Sensor 8, X4: Sensor 12, X5: Sensor 16)
5	Ground
6	Sensor supply voltage
7	Sensor supply voltage
8	Ground
9	Sensor data line (X2: Sensor 1, X3: Sensor 5, X4: Sensor 9, X5: Sensor 13)
10	Sensor data line (X2: Sensor 3, X3: Sensor 7, X4: Sensor 11, X5: Sensor 15)
11	Ground
12	Sensor supply voltage

2.11.3 X6

Würth Elektronik MPC3, 2 rows, 4 pins

Pin	Description
1	Alarm relay output (normally open)
2	Warning relay output (normally open)
3	Alarm relay output (normally open)
4	Warning relay output (normally open)

2.11.4 X7

TE Connectivity HE14, 1 row, 4 pins

Pin	Description
1	Analogue input 1
2	Analogue input 2
3	Analogue input 3
4	Analogue input 4

2.11.5 USS5

Molex MX64, 3 pins, key A

Pin	Description
1	Supply
2	Signal
3	Ground

2.12 Additional Parts

2.12.1 Connectors

An overview of the connectors can be found at *Connectors* (page 44).

2.12.2 USBoard-USS5 Configuration Cable

The basic cable set (order number X211) speeds up the configuration of the USBoard-USS5 and first tests. It consists of:

- Connector X1: Connections for power supply (1 m, flying leads, red = plus, black = minus) and CAN (1 m, female D-Sub 9 connector, no terminating resistor, pin 2 - CAN Low, pin 7 - CAN High)
- USB cable: 1,5 m, USB 2.0, A-type to B-type

This cable set can also be manufactured by the customer using the connectors described at *Connector Descriptions* (page 36).



Fig. 1: USBoard-USS5 configuration cable (X211)

2.12.3 Sensor Cable Sets

The USBoard-USS5 features four connectors for cable sets that connect four sensors each.

Neobotix offers unshielded cable sets in different lengths for first tests and prototyping. The default version (order number X214) is 2 m long and can be plugged into any of the USBoard-USS5's four sensor connectors X2 to X5. Other cable lengths (up to 25 m) and designs are available on request.

It is recommended to manufacture cable sets that meet your individual requirements when moving to the actual application.

2.12.4 Connector Sets

Neobotix offers sets of crimp contacts and connector housing for customers who plan to manufacture the cable sets by themselves and only need the correct parts. These contacts can be crimped with generic tools well enough for first tests and prototyping.

The connector set for the USBoard-USS5 (order number X212) contains mating crimp contacts and housing for all connectors of the USBoard-USS5 except the USB cable.

The set for the ultrasonic sensors (order number X213) contains the crimp contacts and housing for one sensor.

2.12.5 Ultrasonic Sensors

Ultrasonic sensors Bosch USS5.0 with radial connector are available under order number X210.



Fig. 2: Cable set for 4 x USS5 sensors (X214)

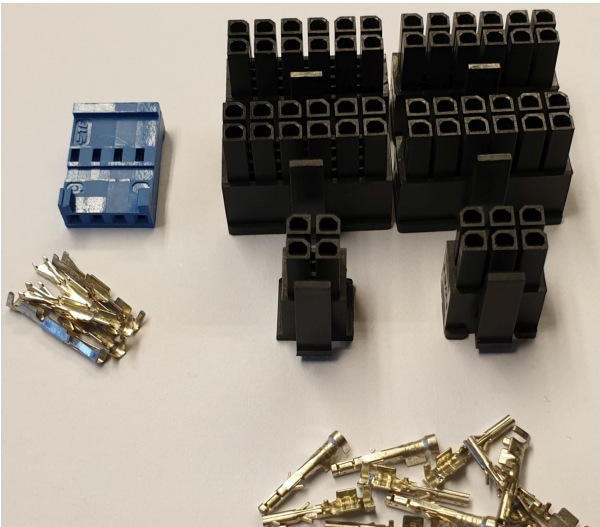

Fig. 3: Connector set for USBoard-USS5 (X212)

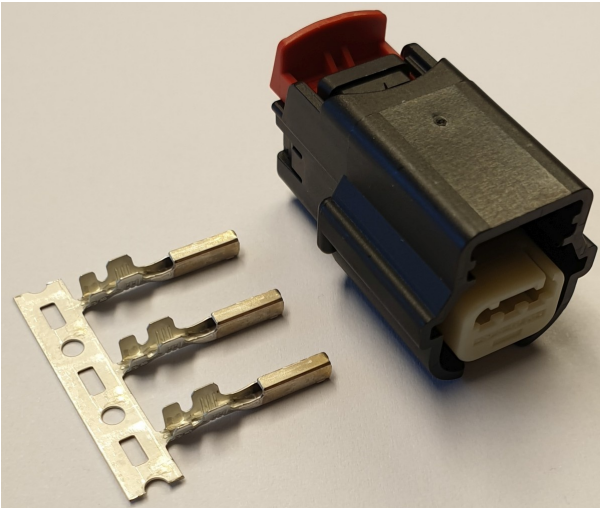

Fig. 4: Connector set for USS5 (X213)



Fig. 5: Ultrasonic sensor Bosch USS5.0 (X210)

2.12.6 USS5 Mounting Frames

The USS5 mounting kit (order number X216) is used to mount the sensor on a front panel.

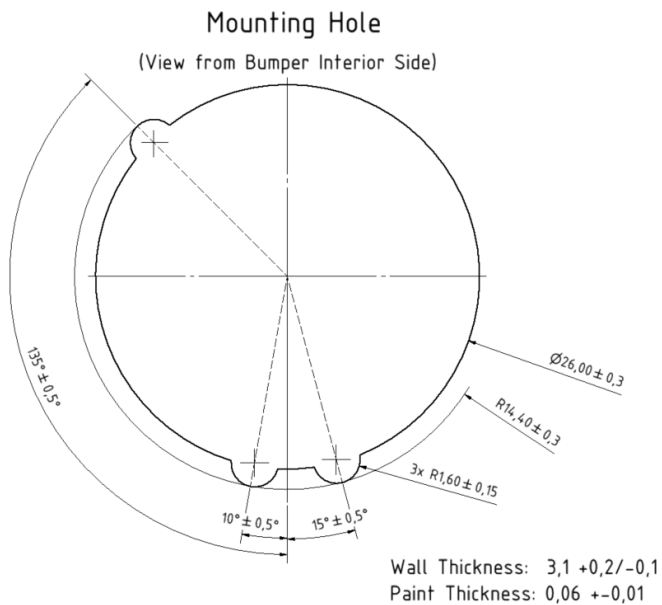

2.13 FAQ

Note: This section is being extended as we get feedback from customers. If your specific questions is not yet listed please either take a look into the full documentation on these pages or get in touch with us directly. We will do our best to help you!

2.13.1 General Questions

2.13.1.1 How do the USBoard-USS5 and ultrasonic sensors work?

Both the basic principle of ultrasonic sensors and the cross-echo operating mode of the USBoard-USS5 are described in detail at *Operating Principle* (page 10).

2.13.1.2 The sensor readings are not what I expected.

Unfortunately this is a common problem of ultrasonic sensors and caused by the physical measuring principle. Different from laser light ultrasound waves are easily disturbed and bounced around which leads to faulty readings in some situations. They also react differently to different materials and surfaces. This is the reason why the USBoard-USS5 is not a safety device.

Please take a look into our *FOV tests* (page 13). We also strongly recommend to do some tests and experiments with the system before going into production.

2.13.1.3 How to get measurement data as fast as possible?

Disabling all sensor channels that are currently not in use will prevent the USBoard-USS5 from trying to send pulses on these channels and from waiting for an echo. This will reduce the cycle time needed for updating measurements from all sensors that are actually used. Please take a look at the parameter set description at *Parameter Set* (page 15) and command `CMD_SET_CHANNEL_ACTIVE` at *Commands* (page 19).

In some applications it might also be an option to use the *Cross Echo Mode* (page 11).

2.13.2 Connection Problems

2.13.2.1 The CAN bus reports errors

Please make sure that there is at least one CAN terminating resistor on the bus. The recommended configuration is one 120 Ohm resistor between CAN High and CAN Low at each physical end of the bus line.

The USBoard-USS5 features a *micro switch* (page 35) to enable the integrated terminating resistor. Please use the GUI to activate the resistor of the USBoard-USS5-IP.

2.13.2.2 The GUI does not connect to the USBoard-USS5

In case of a direct USB connection please check the following:

- Did you select the correct port? Some computers still have internal COM ports that can be mixed up with the virtual port of the USBoard-USS5's USB connection. Try with all available ports.
- Has the port number changed? Different USBoard-USS5 may have different port numbers assigned by the operating system. Please close and restart the GUI to make it update the port list.

2.14 Legal Notes

The general legal notes can be found at *Legal Notes* (page 49).

2.14.1 EU Declaration of Conformity



This product fulfils all relevant directives of the European Union.

2.14.2 RoHS Information



This product complies to the RoHS directives 2011/65/EU (RoHS 2) and 2015/863/EU of the European Parliament and the Council on the restriction of the use of hazardous substances in electrical and electronic equipment.

3.1 TE Connectivity - HE14

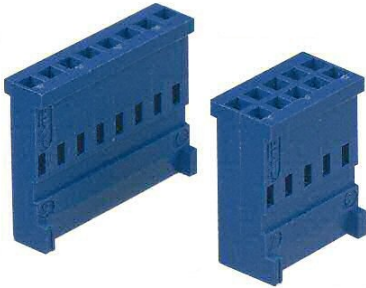

Pins	TE Connectivity	Farnell	RS Components
3 pins, 1 row	281838-3	429582	532-333
4 pins, 1 row	281838-4	429594	532-349
5 pins, 1 row	281838-5	429600	532-355
6 pins, 2 rows	281839-3	429650	532-406
8 pins, 2 rows	281839-4	429661	532-412
10 pins, 2 rows	281839-5	429673	532-428
12 pins, 2 rows	281839-6	429685	532-434



Crimp contacts	TE Connectivity	Farnell	RS Components
AWG 28-24	182734-2	429715	532-456

In Neobotix products the pin assignment of the HE14 connectors is as shown below.

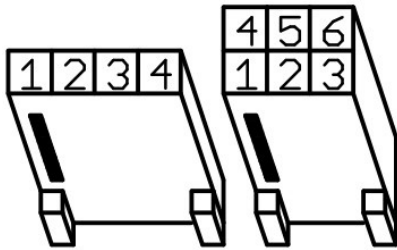

3.2 Würth Elektronik - MPC4

Please check the [Würth Elektronik online catalogue](#)⁵ for details on the MPC4⁶.



Pins (in 2 rows)	Würth Elektronik
2	649002113322
4	649004113322
6	649006113322
8	649008113322
10	649010113322
16	649016113322



Crimp contacts	Würth Elektronik
AWG 24-18	64900613722

In Neobotix products the pin assignment of the MPC4 connectors is as shown below.

⁵ <https://www.we-online.com/en/products/components/overview>

⁶ https://www.we-online.de/katalog/de/em/connectors/wire-to-board/wr_mpc4/

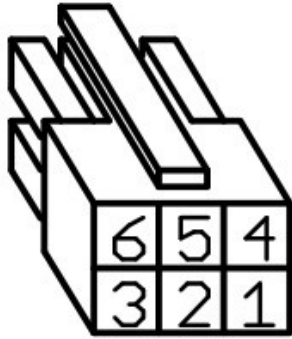

3.3 Würth Elektronik - MPC3

Please check the Würth Elektronik online catalogue⁷ for details on the MPC3⁸.

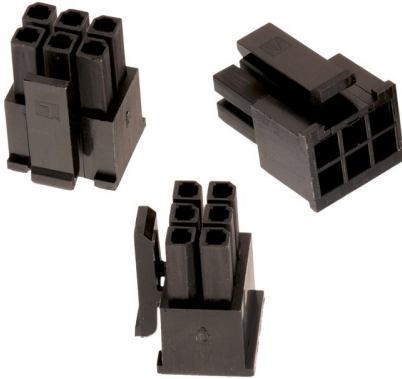

Pins (in 2 rows)	Würth Elektronik
4	662004113322
6	662006113322
12	662012113322



Crimp contacts	Würth Elektronik
AWG 24-20	66200113722

In Neobotix products the pin assignment of the MPC3 connectors is as shown below.

⁷ <https://www.we-online.com/en/products/components/overview>

⁸ https://www.we-online.de/katalog/de/em/connectors/wire-to-board/wr_mpc3/

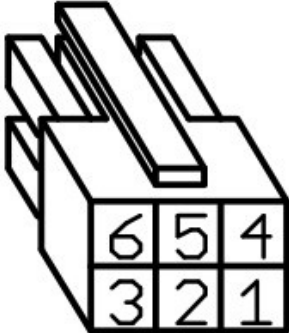

Qualified Personnel

This product must only be modified, commissioned, operated and serviced by qualified personnel. Qualified personnel are defined as persons who

- due to their specialist training and experience have adequate knowledge for the work at hand,
- have been instructed by the responsible robot operator in the operation of the robot or its parts and the currently valid safety guidelines,
- are sufficiently familiar with the applicable official health and safety regulations, directives and generally recognised engineering practice (e.g. DIN standards, VDE stipulations, engineering regulations from other EC member states) that they can assess the work safety aspects of the product and
- have access to this manual and who have read it.

The following groups of persons are generally not considered qualified:

- Employees, interns or other academic staff not familiar with the product,
- visitors and guests,
- all members of other departments of the company or institution in which the product is operated.

This list is not intended to be exhaustive.

5.1 Version Information

The English part of this online documentation has been translated and is not the original. Please refer to the German version in case of uncertainties or questions.

5.2 Liability

Every care has been taken in the preparation of this manual which represents the state of technology at the time of its composing. However, inaccuracies or omissions might occur. Please inform Neobotix in case you notice any.

The Neobotix GmbH cannot be held responsible for any technical or typographical errors and reserves the right to make changes to the product and manual without prior notice. Neobotix makes no warranty of any kind with regard to the material contained within this document, including, but not limited to, the implied warranties of merchantability and fitness for a particular purpose. Neobotix GmbH shall not be liable or responsible for incidental or consequential damages in connection with the improper use of one or more of the products described in this manual.

5.3 Downloads and Further Information

Additional information, data sheets and documentations, also for other products of Neobotix, can be found in the download section on our homepage: <https://www.neobotix-robots.com/service/downloads>.